



功得電子工業股份有限公司
CONQUER ELECTRONICS CO.,LTD.

規格書

Spec. No. SFA-602

Specification For Approval

品名： CRU CQ06LT 系列
耐突波型陶瓷晶片保險絲

Type： CRU CQ06LT
High Inrush SMD L-Type Chip Fuse Series

www.conquer.com.tw

五股廠：新北市五股區五權五路26號(新北產業園區)
Wugu Factory:No.26, Wucyuan 5th Rd., Wugu Dist.,
(New Taipei Industrial Park) New Taipei City
24888, Taiwan
TEL:+886-2-89902189(Rep.)
+886-2-2CONQUER(Rep.)
FAX:+886-2-8990-2577

北投廠：台北市北投區立德路120巷15號
Peitou Factory:No. 15, Lite Road, Peitou,
Taipei 11259, Taiwan.
TEL:+886-2-2895-8895(代表號)
FAX:+886-2-2895-8880



History of Change

REV.	Description	Date	Drawn	Designed	Checked	Approved
1	新制定文件	2012.11.22	陳佳鈺	翁靜好	葉志強	蕭煥益
2	修正系列規格阻抗值與I2t值與目錄一致	2014.03.11	陳佳鈺	翁靜好	葉志強	蕭煥益
3	修正規格書格式、新增產品材料	2014.08.13	陳佳鈺	翁靜好	葉志強	蕭煥益

Conquer Electronics Co., LTD.

No.26, Wucyuan 5th Rd., Wugu Dist.,(New Taipei Industrial Park) New Taipei City 24888, Taiwan TEL:+886-2-8990-2189 (代表號) FAX:+886-2-8990-2577

Peitou Factory : No. 15, Lane 120, Lite Road, Peitou, 11248, Taipei, Taiwan. TEL: +886-2-2895-8895 (代表號) FAX:+886-2-2895-8880

E-mail: conqfuse@ms62.hinet.net Official Website: <http://www.conquer.com.tw>

1 適用範圍

- 1.1 液晶顯示器 LCD Display 【Monitor, Notebook】
- 1.2 電腦週邊 PC Appliance
 【Laptop Computer, Word Processor, CD Drive, MO Drive, Laser Printer and Ink Jet Print】
- 1.3 攜帶型通訊 Portable Communication Machinery
 【PDA, Mobile Phone and Battery Charge for them】
- 1.4 影音週邊 AV Appliances
 【DVC, 8mm VC, Digital Camera, Mini Disk Player, Personal Audio Equipment】
- 1.5 遊戲機週邊 Amusement Machine 【Game equipment, Handy Game equipment】

2 形狀及尺寸如下圖 單位: mm

Shape & Size as following illustrations.

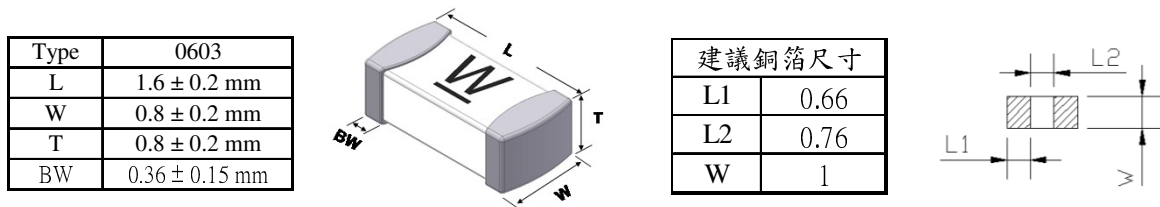

- 2.1 構造形狀 Structure & Shape : 如上圖 As shown in figure above
- 2.2 額定電壓 Rated Voltage: 63V/32V
- 2.3 額定電流 Rated Current: 1A~8A

3 材料 Material:

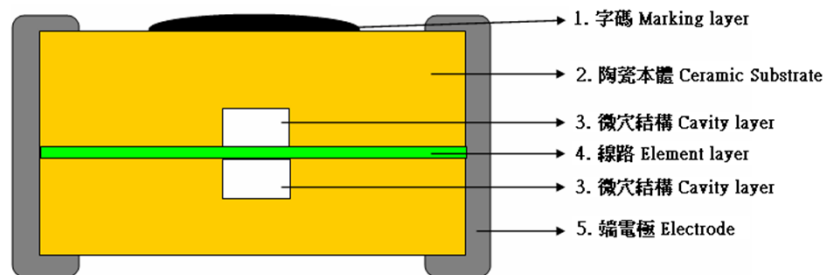

部件編號	部件名稱	組成材料
1	字碼 Marking layer	玻璃 Glass Powders
2	陶瓷本體 Ceramic Substrate	陶瓷 Ceramic
3	微穴結構 Cavity layer	空氣 Air
4	線路 Element layer	銀 Ag
5	端電極 Electrode	銀 Ag、鎳 Nickel、錫 Tin

Conquer Electronics Co., LTD.

No.26, Wucyuan 5th Rd., Wugu Dist., (New Taipei Industrial Park) New Taipei City 24888, Taiwan TEL:+886-2-8990-2189 (代表號) FAX:+886-2-8990-2577

Peitou Factory : No. 15, Lane 120, Lite Road, Peitou, 11248, Taipei, Taiwan. TEL: +886-2-2895-8895 (代表號) FAX:+886-2-2895-8880

E-mail: conqfuse@ms62.hinet.net Official Website: <http://www.conquer.com.tw>



4 電氣特性Electrical Characteristics:

4.1 負載容量: 通過額定電流值 100 % (亦即 1.0 x In A)4小時以上，能繼續通電無任何熔化現象。

Loading Capacity : Through the 100 % rating current (1.0 x In A) loading, and keep current continuously without any melting. (Can keep 4 hours minimum)

4.2 溫度特性: 通過額定電流值100%(亦即 1.0 x In A)1.5小時，繼續維持原加之電流，每隔十分鐘測試一次，連續測三次，溫度不得升高，若使用熱偶式測量方法。(Thermocouple method) 則本體溫升在200°C 以下。

Temperature: Loading the 100 % (1.0 x In A) for 1.5 hours, keep testing it with the original current every 10 minutes. Continue to test it for 3 times. The temperature is not allowed to be higher. The main temperature rise is below 200°C by way of Thermocouple Method.

4.3 過載熔斷: 請參照下表。Melting due to overloading: Details as follows Table.

※最大熔斷時限Operating Characteristics

安培數	100% Rating		200% Rating		300% Rating		1000% Rating	
	Min.	Max.	Min.	Max.	Min.	Max.	Min.	Max.
1A~8A	4 hr		1 sec	120 sec		3 sec		0.05 sec

5 突波實驗: 為適應電感或電容性電路所產之暫態電流。

晶片保險絲的應用，建議客戶端所產生的突波最好小於該保險絲額定電流的5倍。

Surge Test: In order to stand transient current caused by inductive or capacitive.

We suggest application for SMD fuse inrush withstand capacity are better less than 5 times of rating current.

6 遮斷能力 Interrupting rating:

1A~8A : 35 amperes at 63V DC
60 amperes at 32V DC

7 包裝 : 4000 pcs (7") in an inner box. 內盒印明下列標示:料號、額定(電壓、電流、遮斷能力)及安規名稱。包裝材料均符合RoHS或者HF的環保要求,且包裝材料不會和零件發生化學反應,造成不良。

Packing : 4000 pcs (7") in an inner box. The following items indicated on the box.

Mark: Catalog number; ratings (voltage, current, interrupting capacity), and safety mark.

The packing material conforms to ROHS or the HF environmental protection request. And the packing material can't have the chemical reaction with the components.

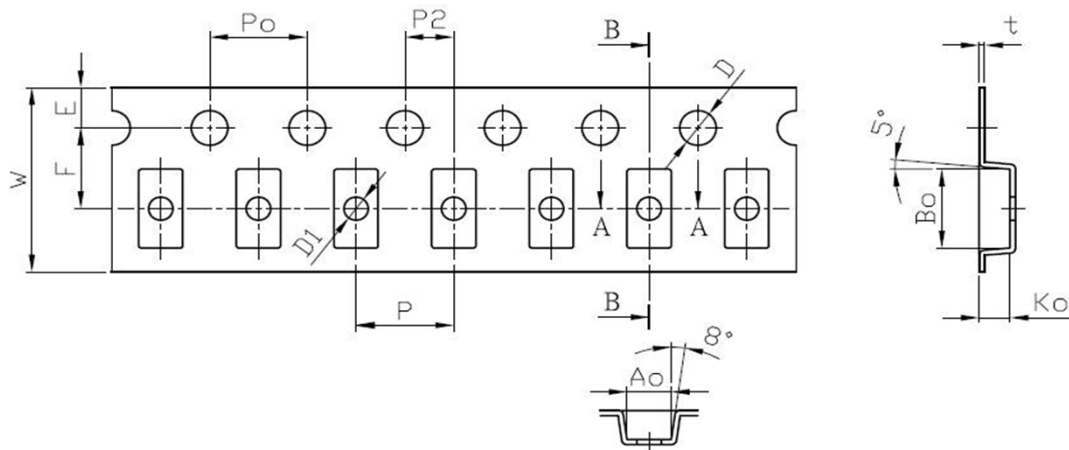

Item	W	P	E	F	P2	D	D1	P ₀	10P ₀	A ₀	B ₀	K ₀	t
Criterion	8.00	4.00	1.75	3.50	2.00	1.50	0.50	4.00	40.00	0.94	1.82	0.92	0.2
Tolerance	±0.10	±0.10	±0.10	±0.05	±0.05	±0.10	±0.10	±0.10	±0.20	±0.10	±0.10	±0.10	±0.05

8 其他 Other:

8.1 除非另有指定，上述機械、電器特性，係於常溫，標準狀況下測試之。

Unless otherwise, specified, all tests to be performed at 25±5°C and 35-75% RH.

8.2 於標準狀況下儲放一年，本品乃確保上述機械與電氣之特性。

After one year's storage under normal condition, this item is guaranteed to meet the requirements mentioned above.

9 標記/安規認證 Mark/ Safety certification:

9.1 標記 Mark

貼紙 LABEL

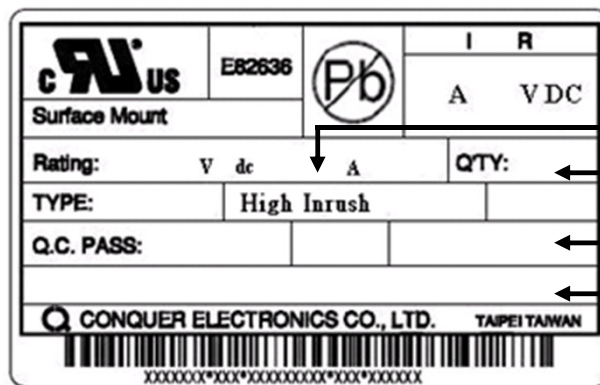

Ampere Rating

Pcs

Product Code

Product Name

ex :

CRU CQ06LT 1A 32V

Product Name	Ampere Rating	IR
CRU CQ06LT *A 32V	1A ~ 8A	60A 32V DC
CRU CQ06LT *A 63V	1A ~ 8A	35A 63V DC

Conquer Electronics Co., LTD.

No.26, Wucyuan 5th Rd., Wugu Dist.,(New Taipei Industrial Park) New Taipei City 24888, Taiwan TEL:+886-2-8990-2189 (代表號) FAX:+886-2-8990-2577

Peitou Factory : No. 15, Lane 120, Lite Road, Peitou, 11248, Taipei, Taiwan. TEL: +886-2-2895-8895 (代表號) FAX:+886-2-2895-8880

E-mail: conqfuse@ms62.hinet.net Official Website: http://www.conquer.com.tw



Approvals	Marking	cRU _{us}	Nominal Resistance Cold Ohms	Nominal Melting I ² t A ² Sec
1 A	H	*	0.1575-0.2925	0.130
1.5 A	K	*	0.0595-0.1105	0.293
2 A	N	*	0.0364-0.0676	0.400
2.5 A	O	*	0.0280-0.0520	0.625
3 A	P	*	0.0182-0.0338	1.170
3.5 A	R	*	0.0154-0.0286	1.838
4 A	S	*	0.0105-0.0195	2.210
5 A	T	*	0.0070-0.0130	2.500
6 A	U	*	0.0049-0.0091	5.040
7 A	V	*	0.0042-0.0078	5.212
8 A	W	*	0.0035-0.0065	7.680

* : 有安規認證 Have safety certify

9.2 UL cRU認證，認證號碼：E82636。
Recognized to meet UL cRU. File No:E82636

10 系列品名列表 series model list :

品名	安培數
CRU CQ06LT ___A ___V	1A~8A

例：CRU CQ06LT A V
 1 2 3 4

- 1 安規認證 Safety certification : CRU
- 2 系列品名 Series Model : CQ06LT
- 3 安培數 Ampere Rating : 1A~8A
- 4 伏特數 Voltage : 63V/32V

Conquer Electronics Co., LTD.

No.26, Wucyuan 5th Rd., Wugu Dist.,(New Taipei Industrial Park) New Taipei City 24888, Taiwan TEL:+886-2-8990-2189 (代表號) FAX:+886-2-8990-2577

Peitou Factory : No. 15, Lane 120, Lite Road, Peitou, 11248, Taipei, Taiwan. TEL: +886-2-2895-8895 (代表號) FAX:+886-2-2895-8880

E-mail: conqfuse@ms62.hinet.net Official Website: <http://www.conquer.com.tw>



11 IT曲線圖 Clear Time Curve(I vs t curve)

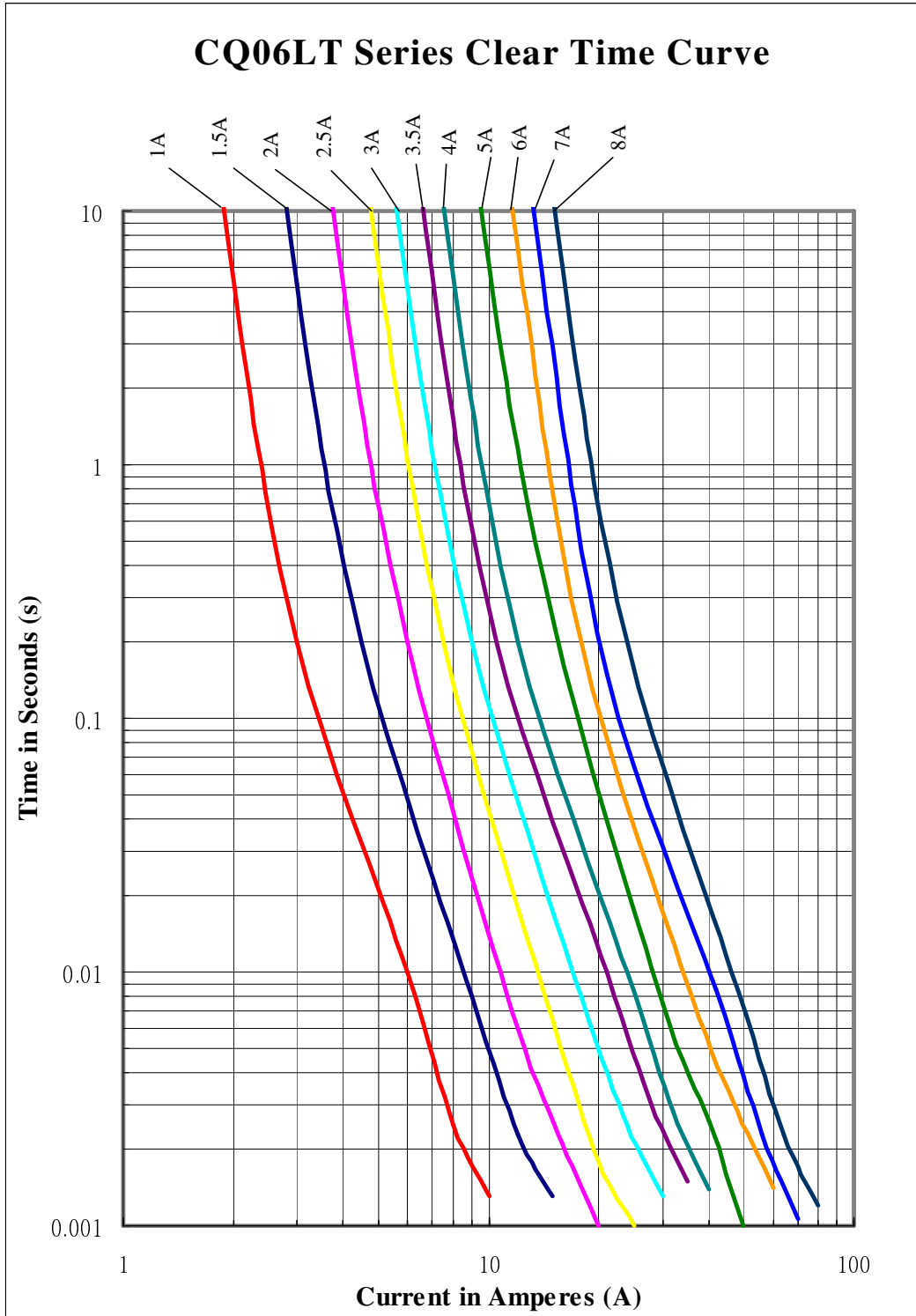

Conquer Electronics Co., LTD.

No.26, Wucyuan 5th Rd., Wugu Dist.,(New Taipei Industrial Park) New Taipei City 24888, Taiwan TEL:+886-2-8990-2189 (代表號) FAX:+886-2-8990-2577

Peitou Factory : No. 15, Lane 120, Lite Road, Peitou, 11248, Taipei, Taiwan. TEL: +886-2-2895-8895 (代表號) FAX:+886-2-2895-8880

E-mail: conqfuse@ms62.hinet.net Official Website: <http://www.conquer.com.tw>



12 I^2t 曲線圖 Standing Pulse (I^2t vs t curve)

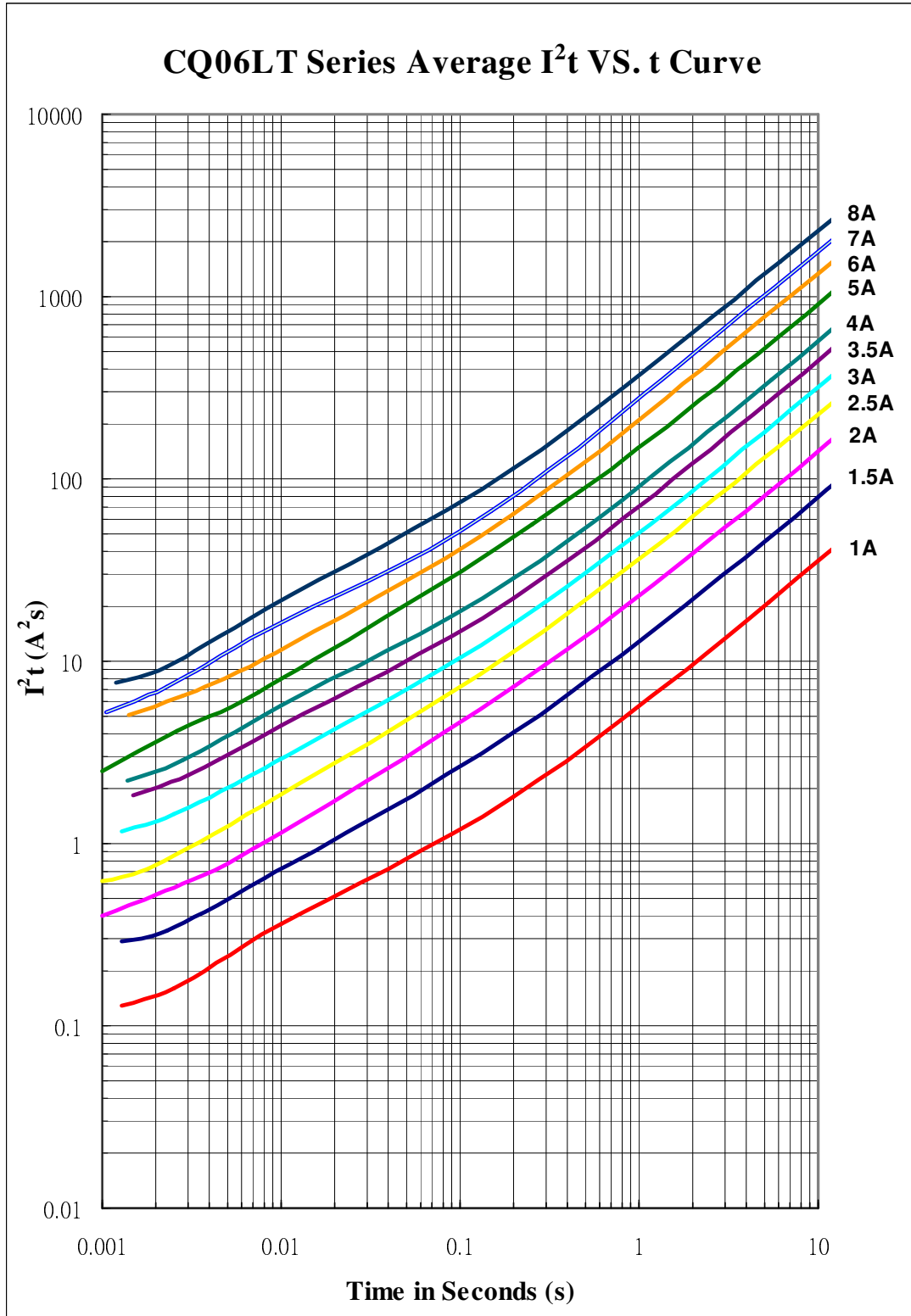

Conquer Electronics Co., LTD.

No.26, Wucyuan 5th Rd., Wugu Dist., (New Taipei Industrial Park) New Taipei City 24888, Taiwan TEL:+886-2-8990-2189 (代表號) FAX:+886-2-8990-2577

Peitou Factory : No. 15, Lane 120, Lite Road, Peitou, 11248, Taipei, Taiwan. TEL: +886-2-2895-8895 (代表號) FAX:+886-2-2895-8880

E-mail: conqfuse@ms62.hinet.net Official Website: <http://www.conquer.com.tw>

13 焊接方法 Soldering Method :

- 13.1 手焊 Hand soldering : 350°C, 3 Sec. max
- 13.2 波焊 Wave soldering : 260°C, 10 Sec. max
- 13.3 迴焊 Reflow soldering : 260°C, 30 Sec. max

14 迴焊建議曲線圖 Recommended Reflow Soldering Curve :

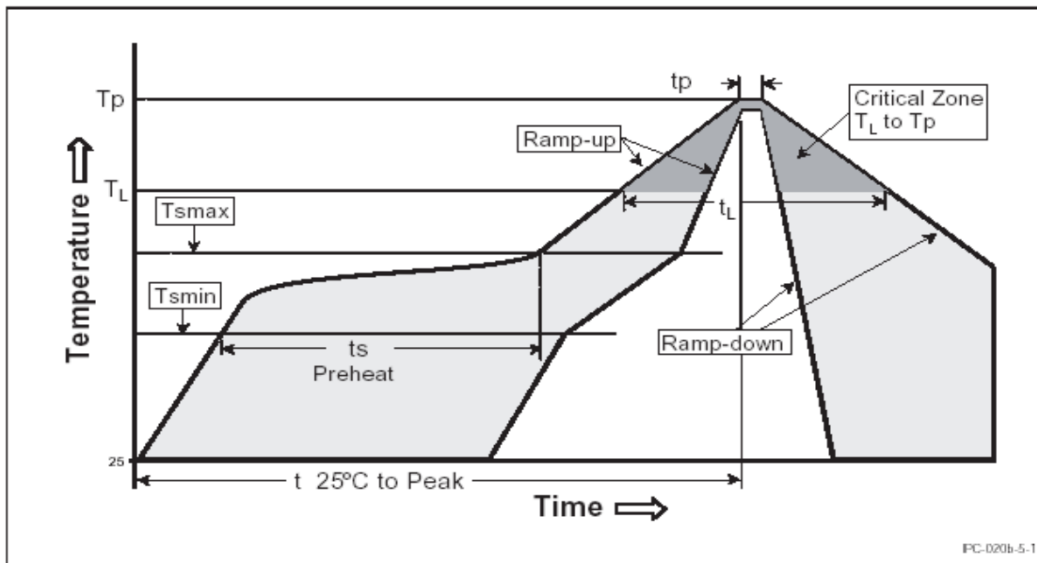

Reflow Condition		Pb-free assembly
Pre Heat	Temperature Min (T_s (min))	150°C
	Temperature Max (T_s (max))	200°C
	Time (Min to Max) (t_s)	60-180 seconds
Average Ramp-up Rate (Liquidus Temp (T_L) to peak)		3°C/second max
T_s (max) to T_L -Ramp-up Rate		5°C/second max
Reflow	Temperature (T_L) (Liquidus)	217°C
	Time (t_L)	60-150 second
Peak Temperature (T_P)		260 ^{+0/-5} °C
Time within 5°C of actual peak Temperature (t_p)		10 ~ 30 seconds
Ramp-down Rate		6°C/second max
Time 25°C to peak Temperature (t 25°C to peak)		8 minutes man
Do not exceed		260°C



15 L-TYPE 溫度曲線圖 Temperature Derating curve

15.1 環境溫度對應電流承載能力，請參照下曲線圖。

Ambient temperature on current-carrying capacity. Details as follows curve.

15.2 工作溫度 Operating Temperature Range : $-55^{\circ}\text{C} \sim 125^{\circ}\text{C}$

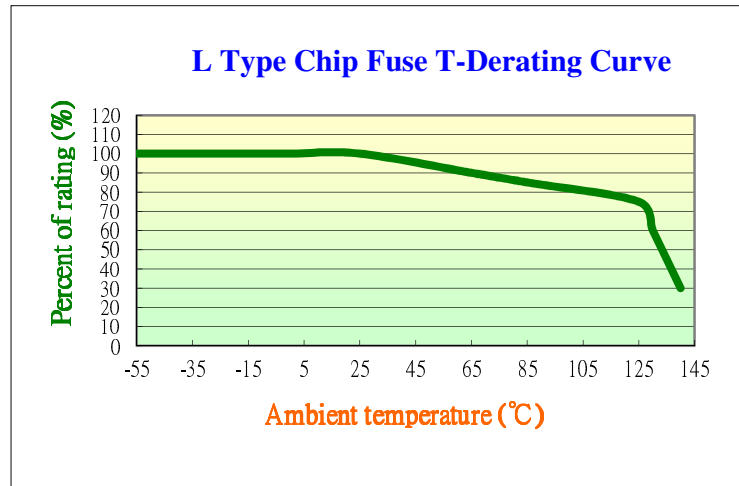

16 信賴性規範 Product Characteristics & Reliability Tests

Test item	Test Description & Reference
Humidity unload test	MIL-STD-202G, Method 103B, Test Condition A Heat ($40 \pm 0.5^{\circ}\text{C}$) & High Humidity ($95 \pm 1\% \text{ RH}$), 240 hours, $\Delta R < 15\%$
Thermal shock test	MIL-STD-202G, Method 107G, Test Condition B Temperature setup : $25^{\circ}\text{C} \sim -65^{\circ}\text{C} \sim 25^{\circ}\text{C} \sim 125^{\circ}\text{C}$ Time setup : -65°C (15min) $\sim 25^{\circ}\text{C}$ (5min) $\sim 125^{\circ}\text{C}$ (15min) $\sim 25^{\circ}\text{C}$ (5min) , 5 cycles, $\Delta R < 15\%$
Vibration test	MIL-STD-202G, Method 201A Frequency setup : $10 \sim 55 \sim 10 \text{ Hz}$ Time setup : 1 Minute/cycle (X-Y-Z, 120 Cycles, 6hours) , $\Delta R < 15\%$
Salt spray Test	MIL-STD-202G, Method 101E, Test Condition A Salt spray concentration : $5 \pm 1\%$ Test liquid temperature : $35 \pm 0.5^{\circ}\text{C}$ 96hours, $\Delta R < 15\%$
Solderability test	Reference IEC 68-2-58 Temperature setup : $235 \pm 5^{\circ}\text{C}$, $2 \pm 0.2 \text{ sec}$ After test terminal electrode wetting area must be greater than 95%
Resistance to Soldering Heat Test	Reference IEC 68-2-58 Temperature setup : $260 \pm 5^{\circ}\text{C}$, $10 \pm 1 \text{ sec}$ $\Delta R < 15\%$

Conquer Electronics Co., LTD.

No.26, Wucyuan 5th Rd., Wugu Dist., (New Taipei Industrial Park) New Taipei City 24888, Taiwan TEL:+886-2-8990-2189 (代表號) FAX:+886-2-8990-2577

Peitou Factory : No. 15, Lane 120, Lite Road, Peitou, 11248, Taipei, Taiwan. TEL: +886-2-2895-8895 (代表號) FAX:+886-2-2895-8880

E-mail: conqfuse@ms62.hinet.net Official Website: <http://www.conquer.com.tw>